

PlumbingSupply.com

Order Verification Form

Signature Required Below

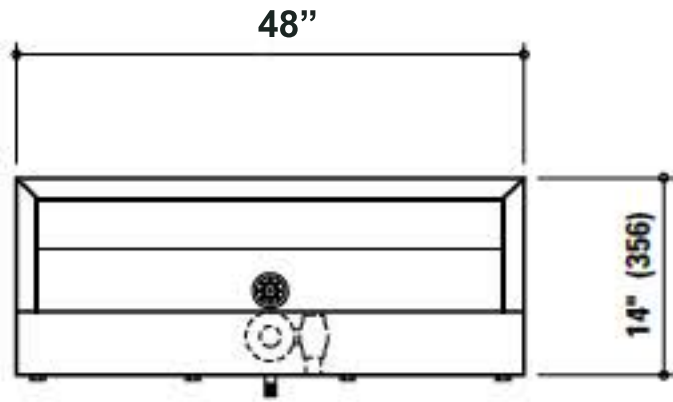

Due to continuous product improvement Metcraft reserves the right to make changes in design and specifications without prior notice. All dimensions should be verified with the factory for current information.

1. 3" [76] Diameter wall opening for waste outlet
2. 1" [25] Diameter wall openings for anchors. (8)

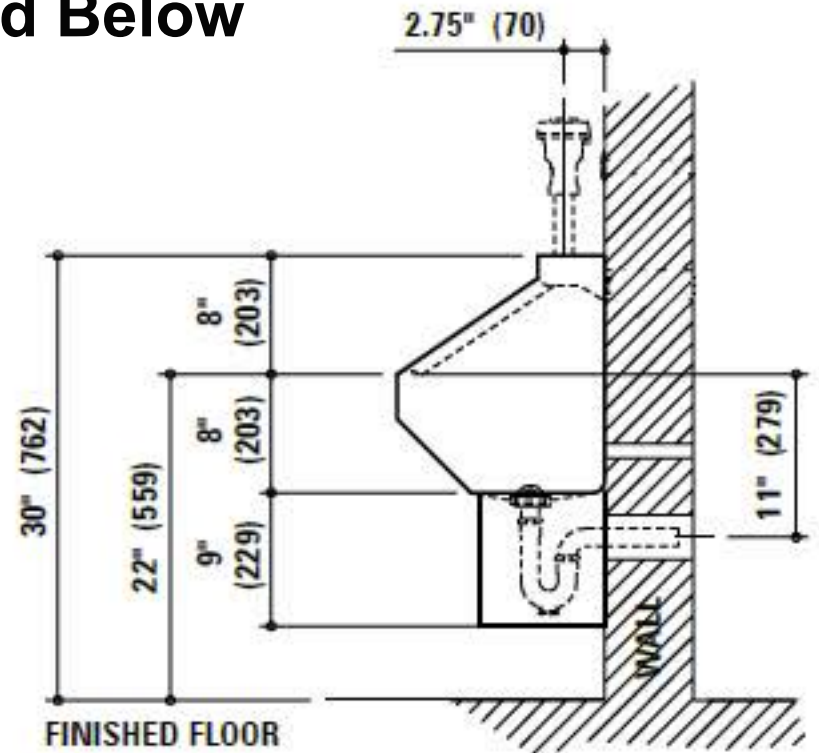

WALL THICKNESS AND TYPE (Must Specify)

Thickness: _____ Type: Concrete Block Steel

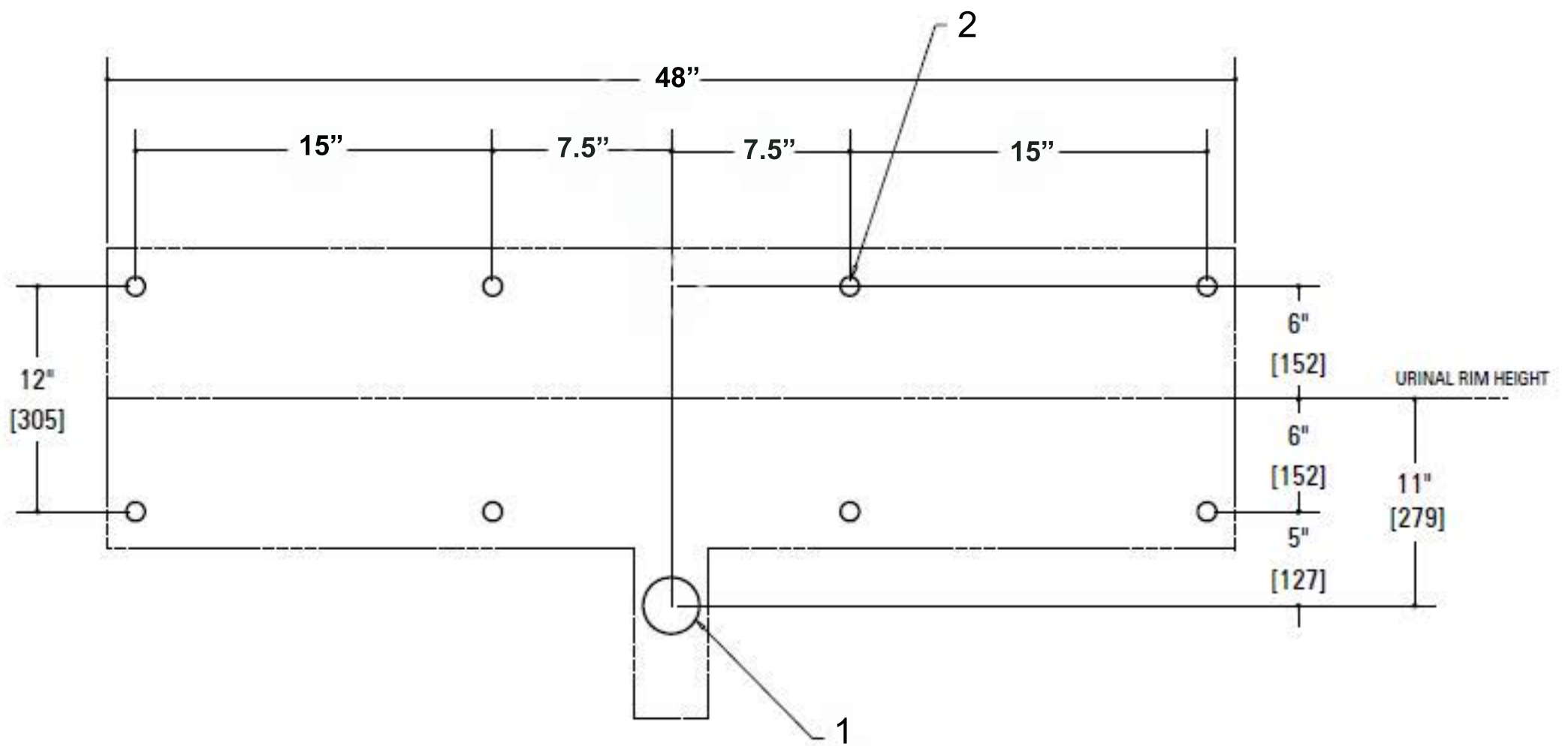

HOLES FOR CORE DRILLING OR STEEL PLATE WALLS

WITH A168 OPTION - includes Metal Template for Wall Openings

Dear Customer,

Verification must be received before order can be entered for shipment.

Please sign below to verify the 7151 Urinal with A168 metal template meets your requirements.

X _____

Customer Signature

Date: _____

Please print name and return to:

PlumbingSupply Group LLC - FAX: 530-891-0654

EMAIL: sales@plumbingsupply.com