

3D
SCALE 1/8

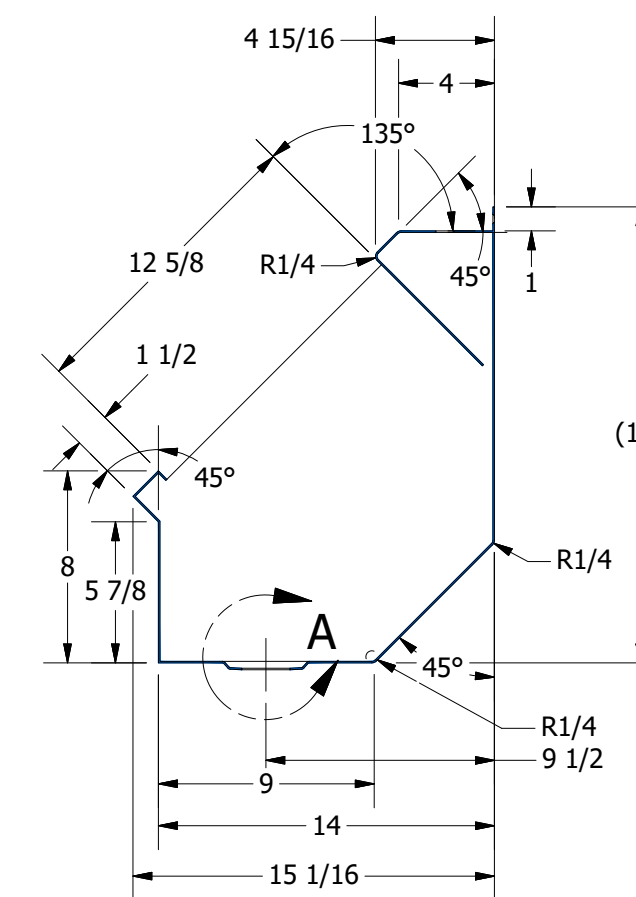

SECTION A-A
SCALE 1/8

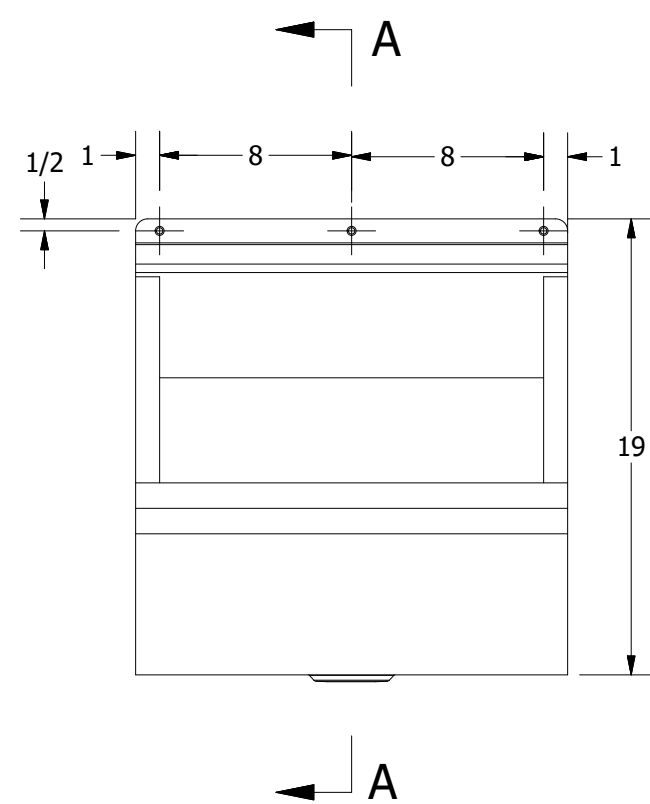
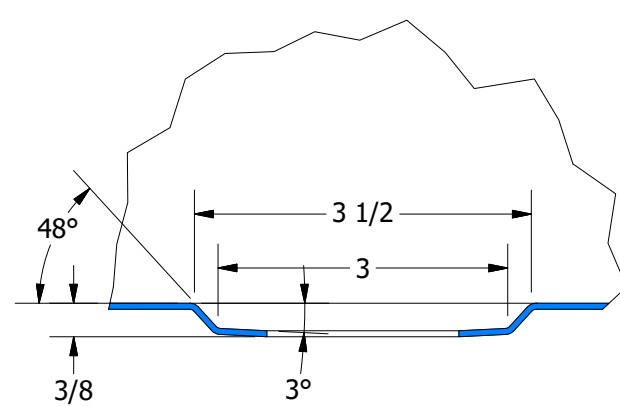

DETAIL A
SCALE 1 / 2

REV	DESCRIPTION	DATE	APPROVED
REVISION HISTORY			



PART NUMBER	PA.18FV	TITLE	PALUXY FLUSH VALVE URINAL		
PRODUCT CATEGORY	URINAL	DESCRIPTION	16GA FLUSH VALVE URINAL		
THE INFORMATION CONTAINED IN THIS DRAWING IS THE SOLE PROPERTY OF GRIFFIN PRODUCTS, INC. ANY REPRODUCTION IN PART OR AS A WHOLE WITHOUT THE WRITTEN PERMISSION FROM GRIFFIN PRODUCTS, INC. IS PROHIBITED.		MATERIAL	16GA (0.06) 304 STAINLESS STEEL		
DRW. BY / DATE	DNZ 08/23/18	APPROVED BY / DATE	REV.	SCALE	SIZE SHEET
			1/8	C	1 / 1

ALL DIMENSIONS ARE IN X INCHES