

DETAIL A
SCALE 1 / 2

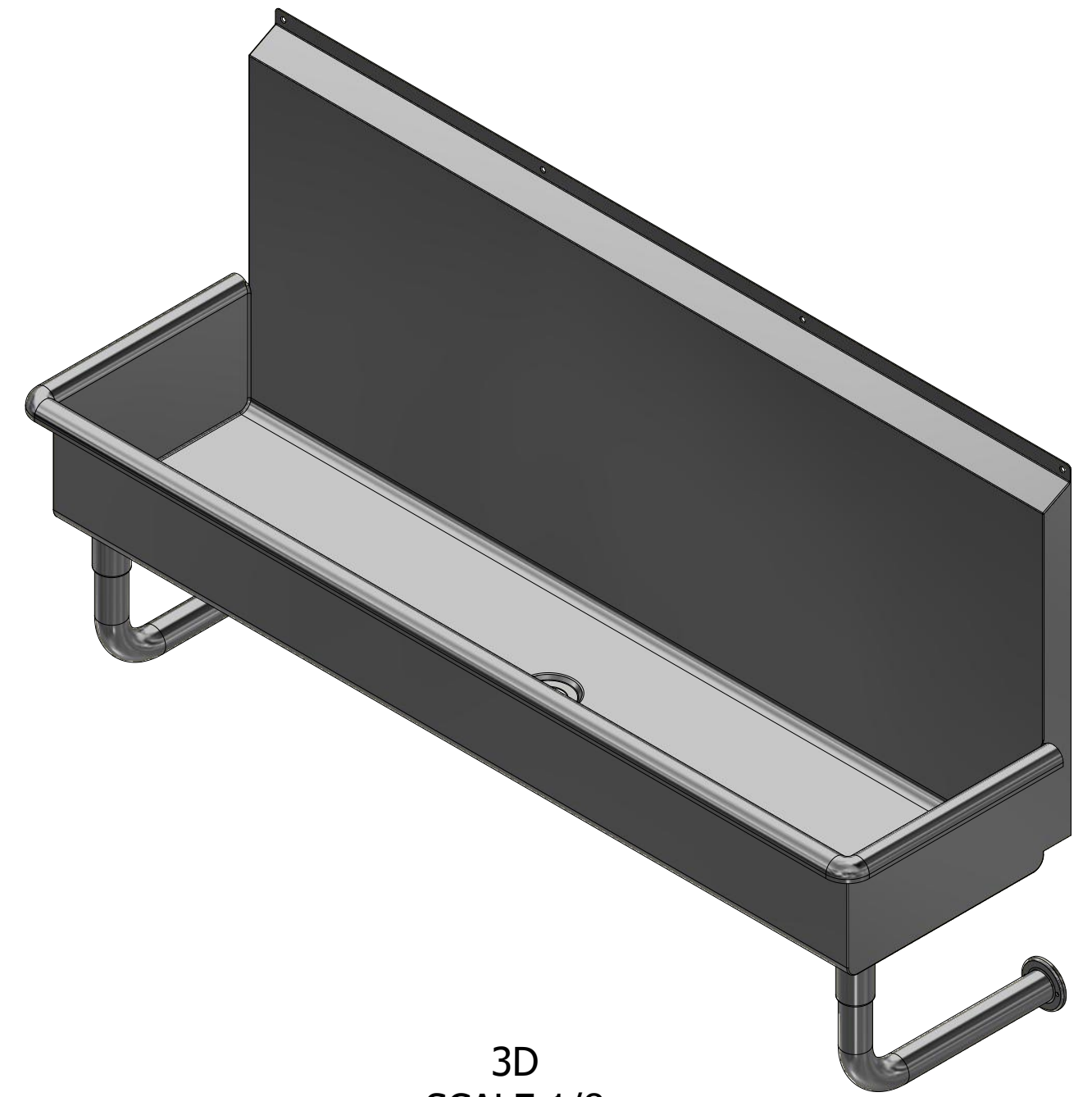

3D
SCALE 1/8

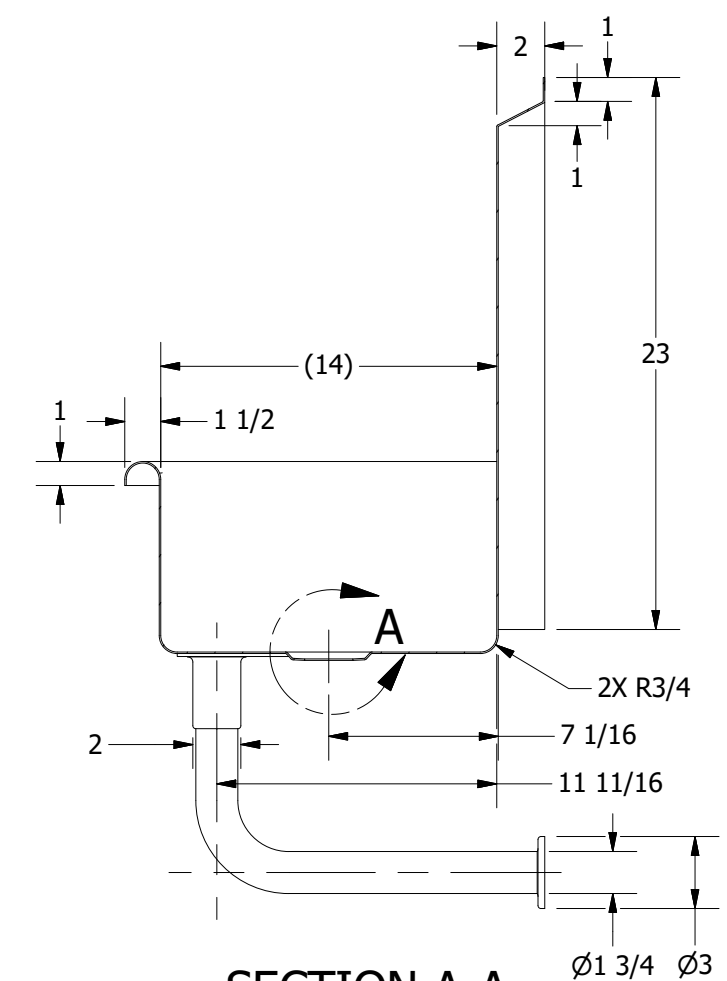
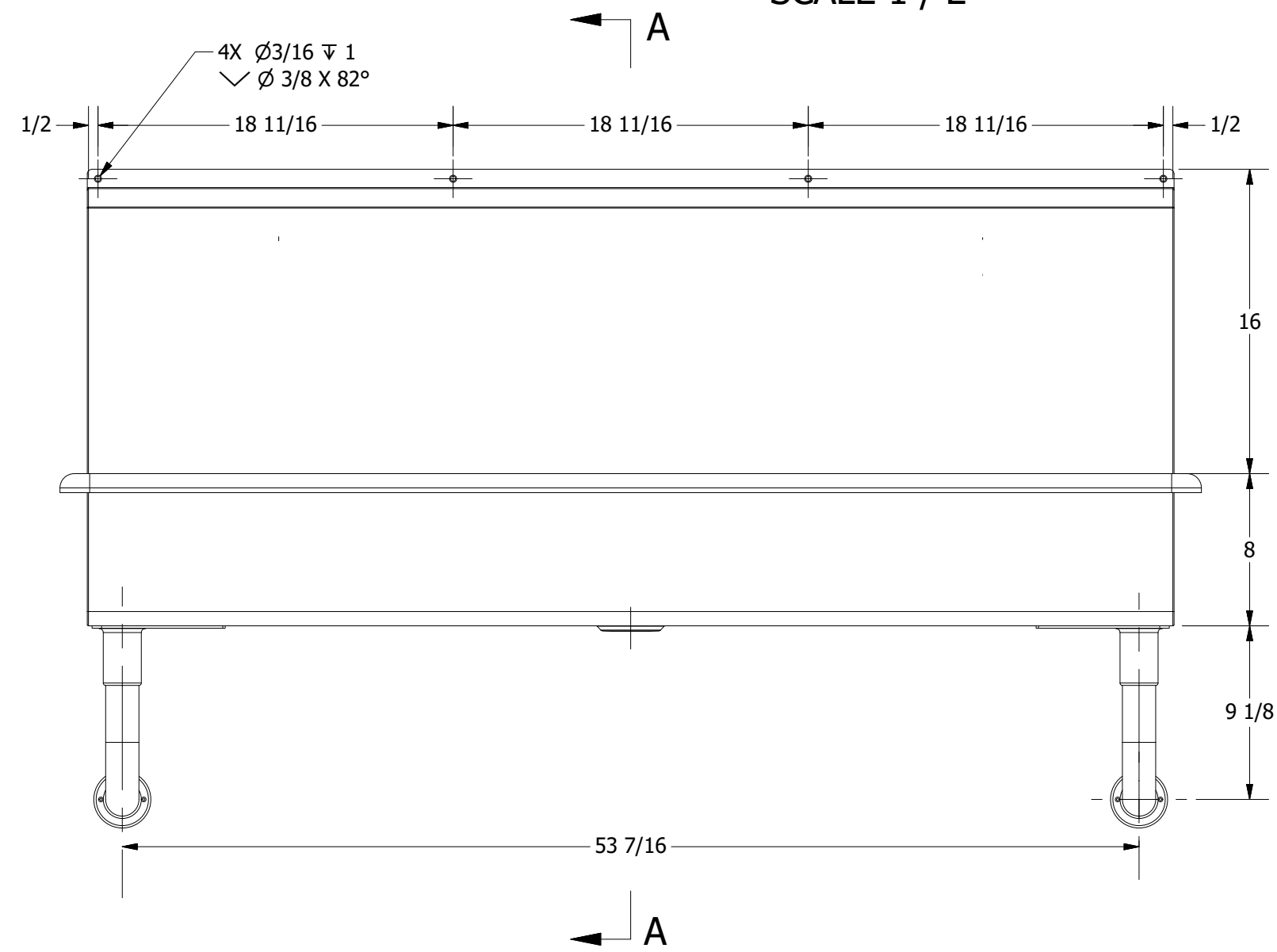

SECTION A-A
SCALE 1/8

REV	DESCRIPTION	DATE	APPROVED
REVISION HISTORY			



PART NUMBER	PA.60FP	TITLE	PALUXY
PRODUCT CATEGORY	URINAL	DESCRIPTION	16 GA PALUXY - FLUSH PIPE URINAL
THE INFORMATION CONTAINED IN THIS DRAWING IS THE SOLE PROPERTY OF GRIFFIN PRODUCTS, INC. ANY REPRODUCTION IN PART OR AS A WHOLE WITHOUT THE WRITTEN PERMISSION FROM GRIFFIN PRODUCTS, INC. IS PROHIBITED.		MATERIAL	16GA (0.06) 304 STAINLESS STEEL
DRW. BY / DATE	DNZ 08/23/18	APPROVED BY / DATE	
		ALL DIMENSIONS ARE IN X INCHES	
REV.	SCALE	SIZE	SHEET
	1/8	C	1 / 1