

SECTION A-A
SCALE 1:12

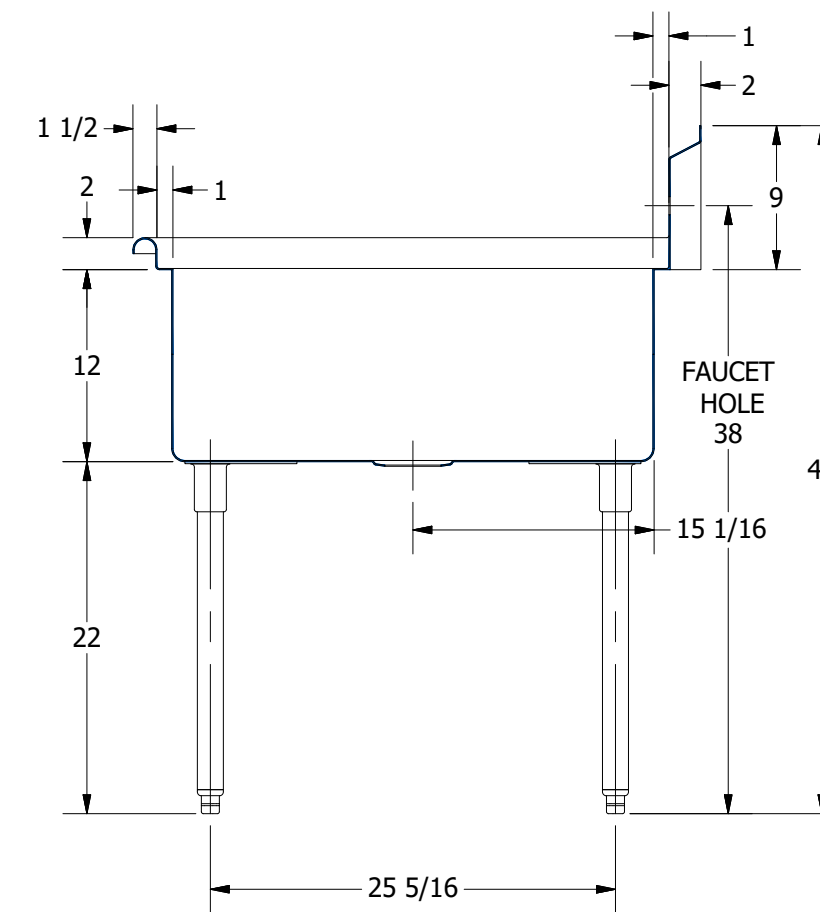

SECTION B-B
SCALE 1:12

REV	DESCRIPTION	DATE	APPROVED
REVISION HISTORY			



PART NUMBER	323.44	TITLE	SABINE SERIES SCULLERY SINK		
PRODUCT CATEGORY	SCULLERY SINK	DESCRIPTION	16GA 3 COMPARTMENTS SINK WITH L&R DRAINBOARDS		
THE INFORMATION CONTAINED IN THIS DRAWING IS THE SOLE PROPERTY OF GRIFFIN PRODUCTS, INC. ANY REPRODUCTION IN PART OR AS A WHOLE WITHOUT THE WRITTEN PERMISSION FROM GRIFFIN PRODUCTS, INC. IS PROHIBITED.		MATERIAL	16GA (0.06 in) 304 STAINLESS STEEL		
DRW. BY / DATE	DNZ 01/24/18	APPROVED BY / DATE	REV.	SCALE	SIZE SHEET
			1:12	C	1 / 1