

3D
SCALE 1/12

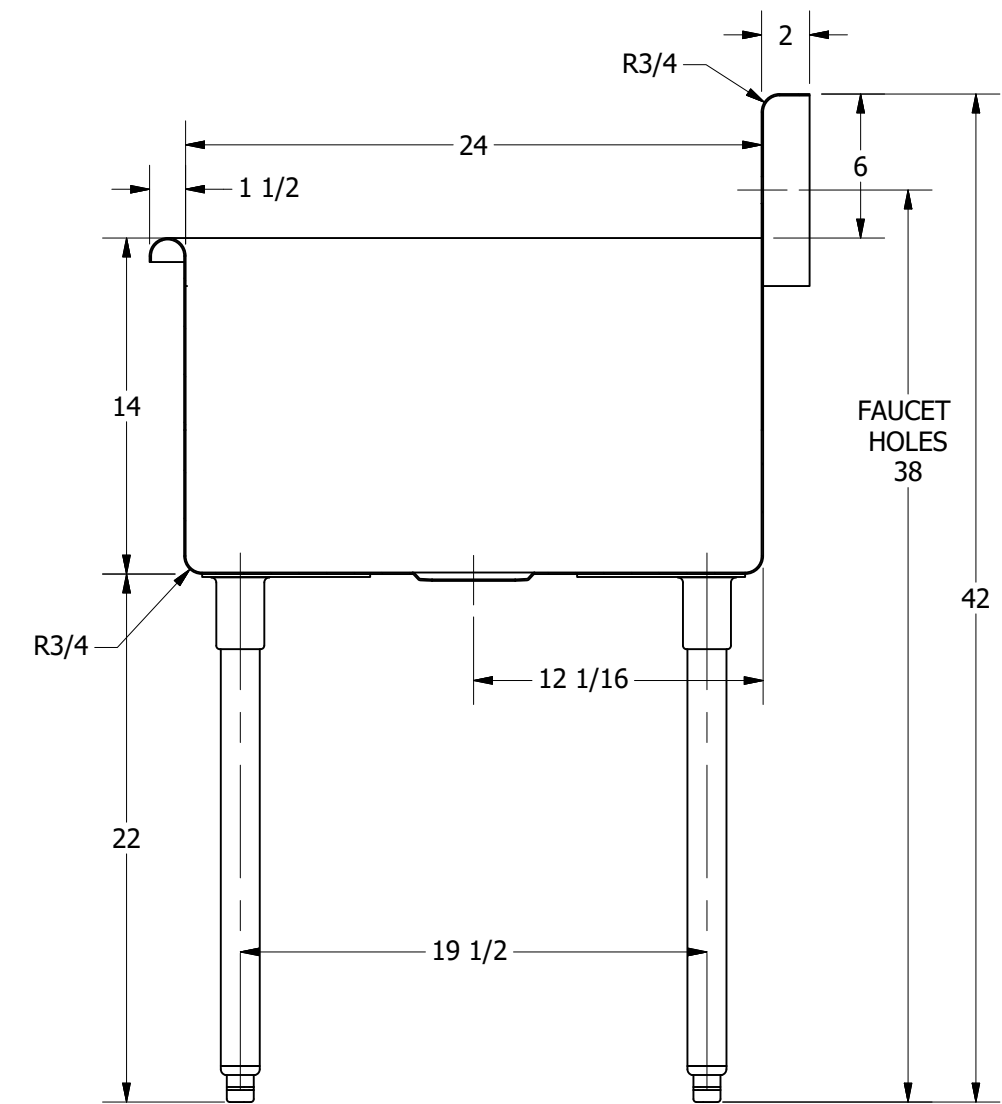
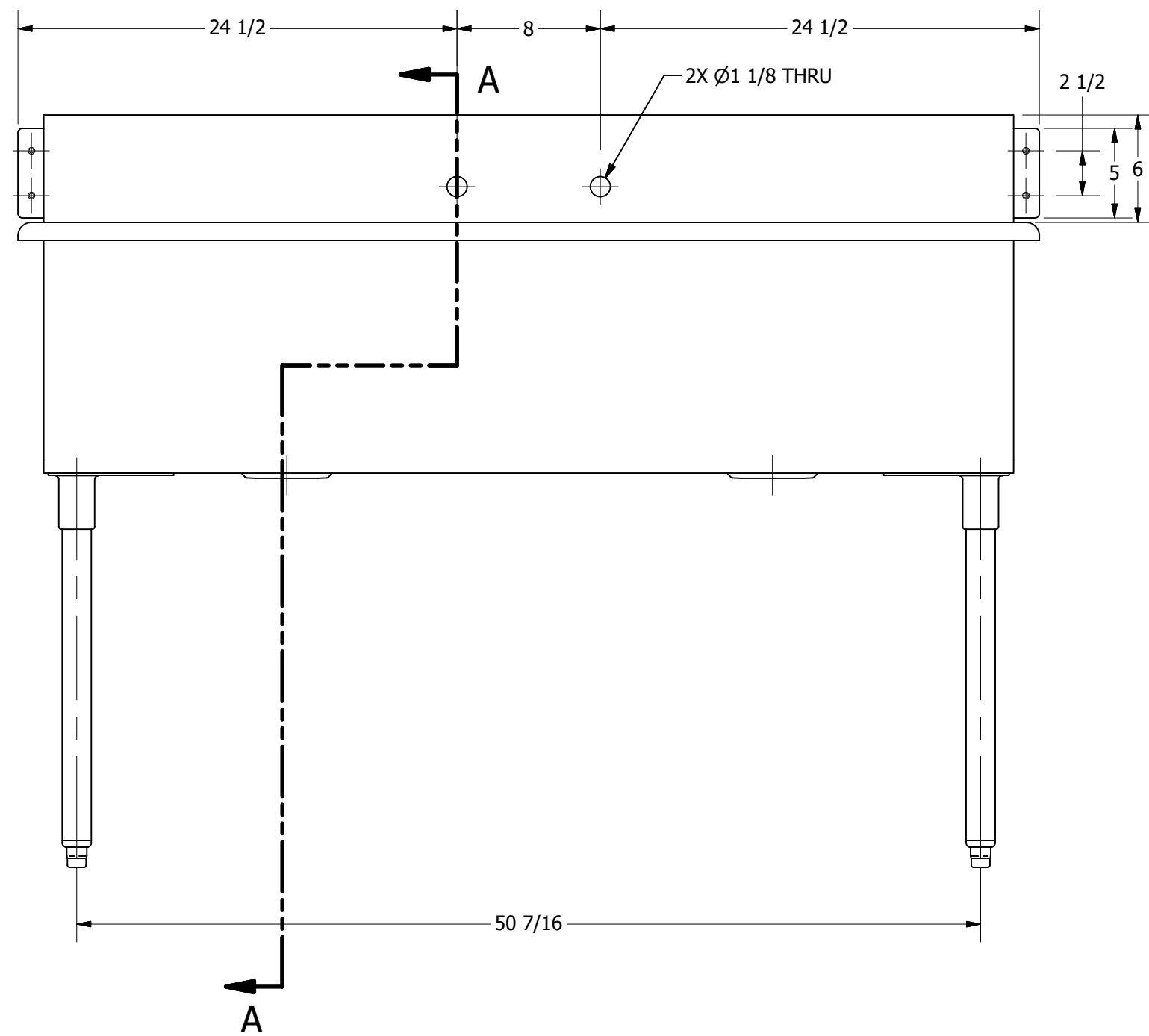

SECTION A-A
SCALE 1/8

REV	DESCRIPTION	DATE	APPROVED

REVISION HISTORY



PART NUMBER	TE 274.00	TITLE	TERRELL SERIES SQUARE SINK
PRODUCT CATEGORY	SQUARE SINK	DESCRIPTION	16GA 2 COMPARTMENTS SINK
THE INFORMATION CONTAINED IN THIS DRAWING IS THE SOLE PROPERTY OF GRIFFIN PRODUCTS, INC. ANY REPRODUCTION IN PART OR AS A WHOLE WITHOUT THE WRITTEN PERMISSION FROM GRIFFIN PRODUCTS, INC. IS PROHIBITED.		MATERIAL	16GA (0.06 in) 304 STAINLESS STEEL
DRW. BY / DATE	DNZ 01/24/18	APPROVED BY / DATE	
ALL DIMENSIONS ARE IN X INCHES		REV.	SCALE
		1/8	
		SIZE	SHEET
		C	1 / 1