

3D  
SCALE 1/12

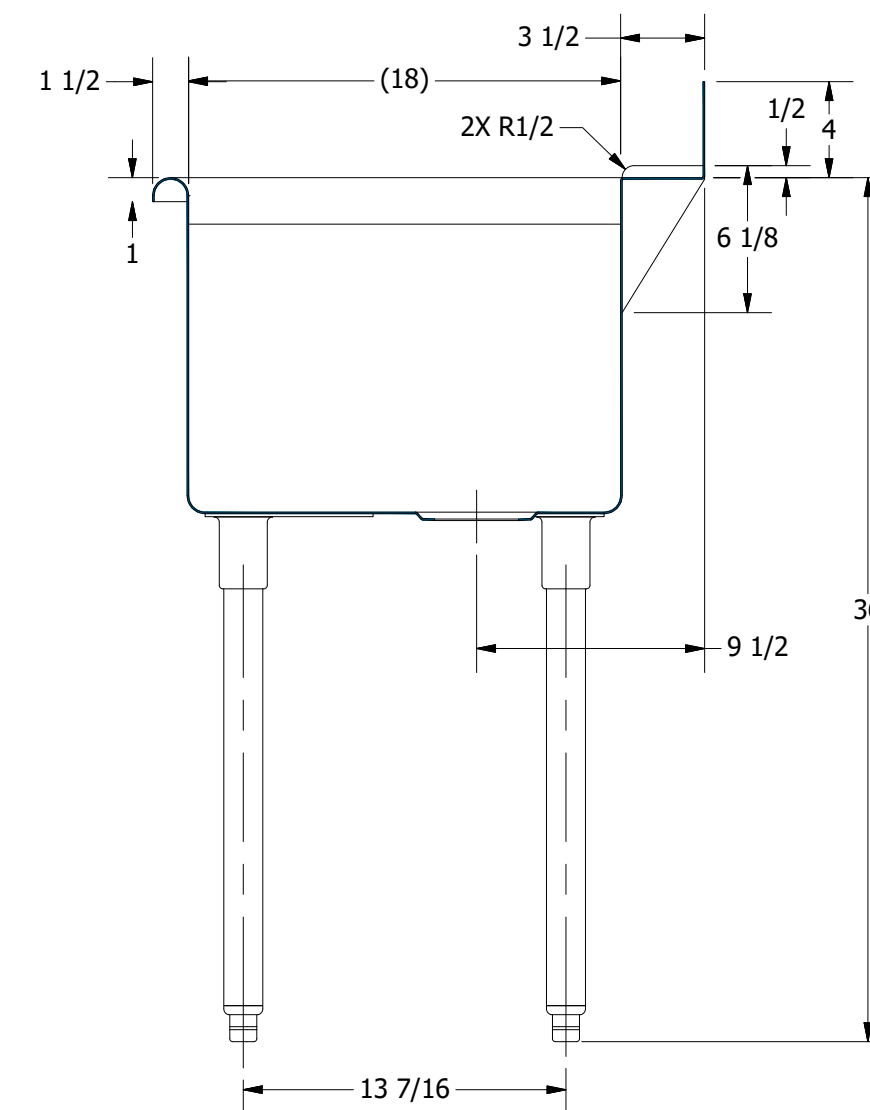

SECTION A-A  
SCALE 1/8

REV	DESCRIPTION	DATE	APPROVED
REVISION HISTORY			

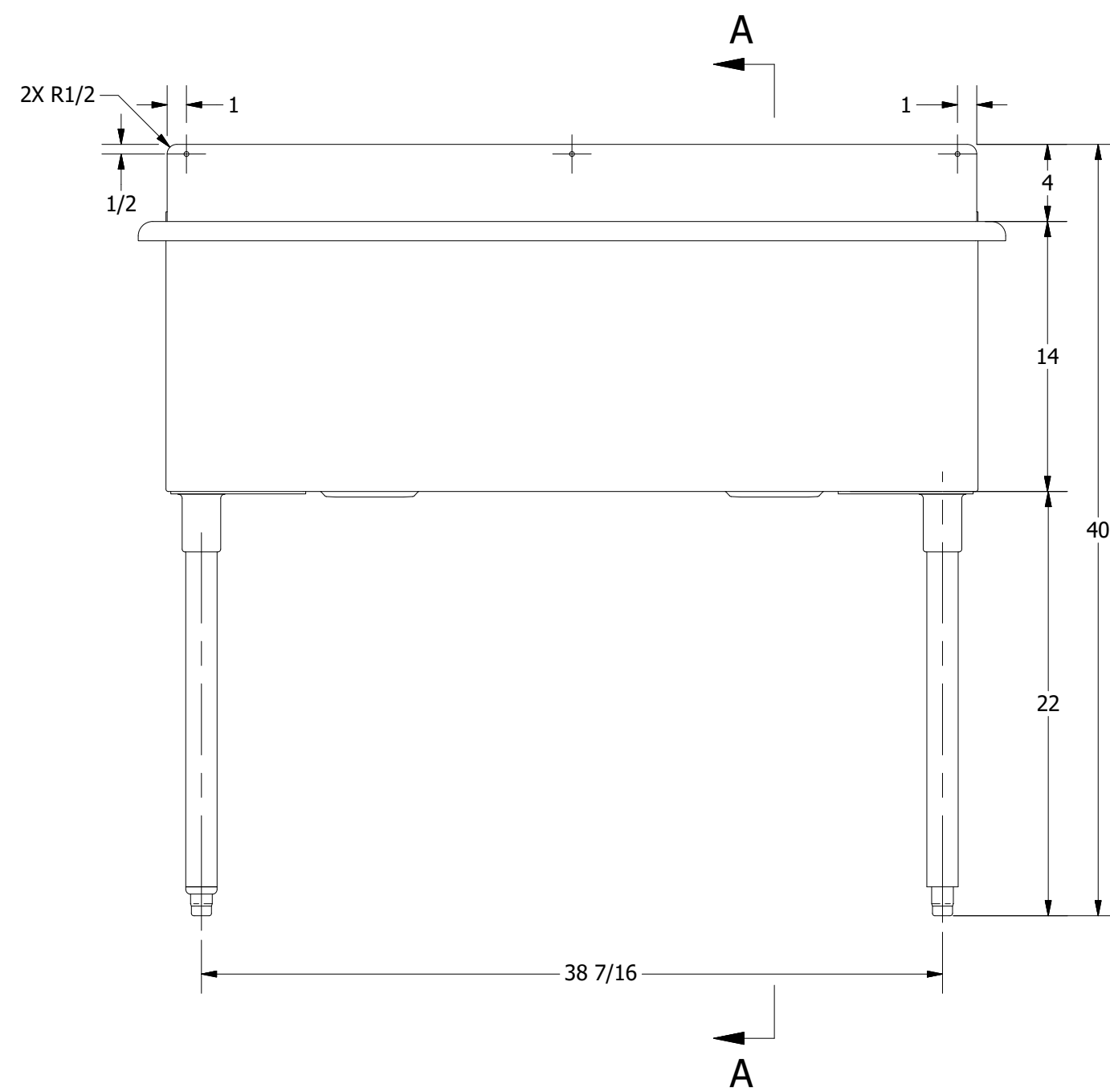

PART NUMBER <b>LT-218.228</b>		TITLE MEDINA SERIES UTILITY SINK	
PRODUCT CATEGORY UTILITY SINK		DESCRIPTION 16 GA UTILITY SINK	
MATERIAL 14GA (0.075 in) 304 STAINLESS STEEL		ALL DIMENSIONS ARE IN X INCHES	
DRW. BY / DATE DNZ 09/17/18	APPROVED BY / DATE	REV. SCALE 1/8	SIZE SHEET C 1 / 1