

3D  
SCALE 1/12

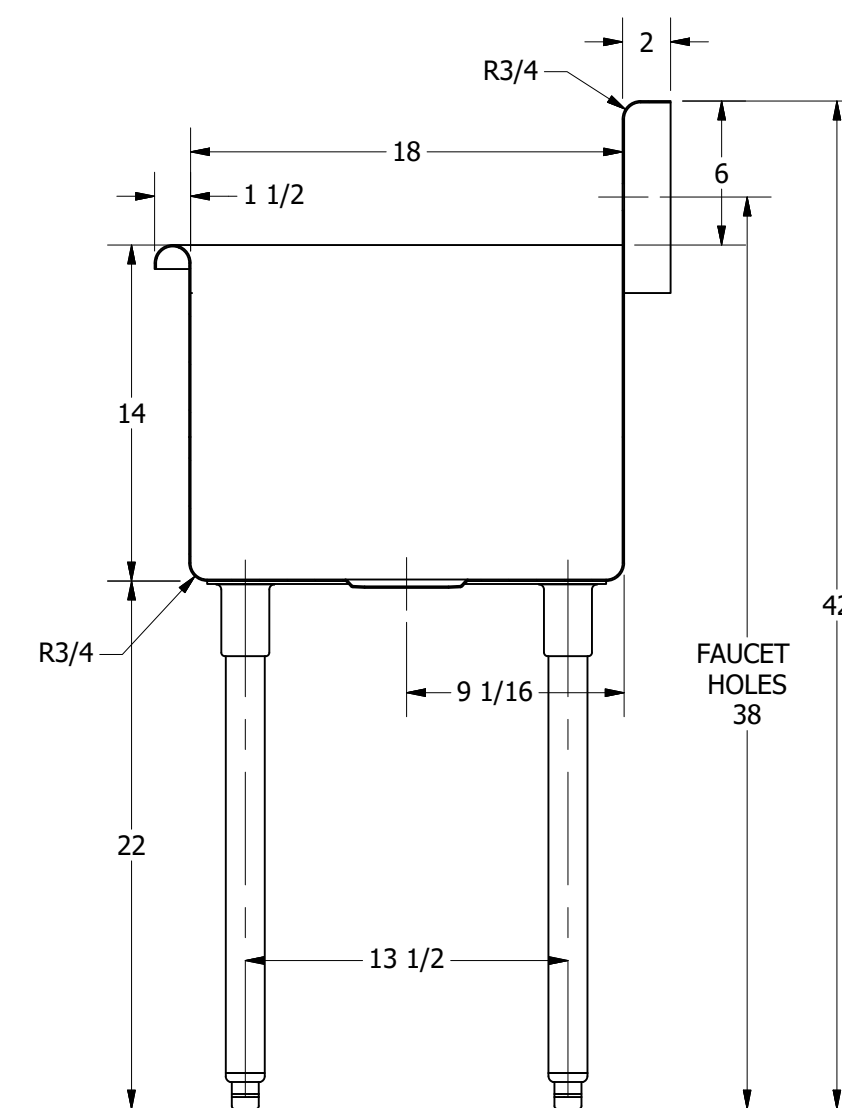

SECTION A-A  
SCALE 1/8

REV	DESCRIPTION	DATE	APPROVED

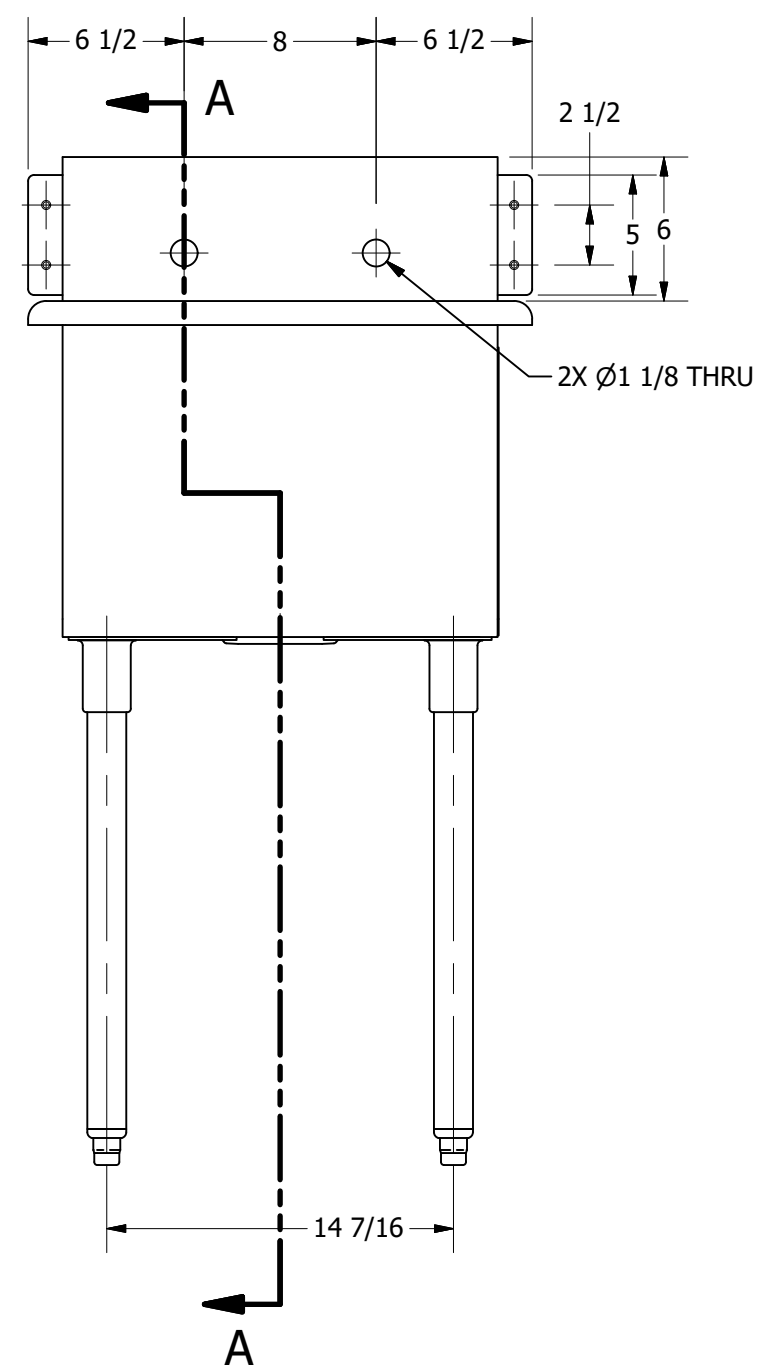

PART NUMBER	<b>TE 188.00</b>	TITLE	TERRELL SERIES SQUARE SINK
PRODUCT CATEGORY	SQUARE SINK	DESCRIPTION	16GA 1 COMPARTMENT SINK
THE INFORMATION CONTAINED IN THIS DRAWING IS THE SOLE PROPERTY OF GRIFFIN PRODUCTS, INC. ANY REPRODUCTION IN PART OR AS A WHOLE WITHOUT THE WRITTEN PERMISSION FROM GRIFFIN PRODUCTS, INC. IS PROHIBITED.		MATERIAL	16GA (0.06 in) 304 STAINLESS STEEL
DRW. BY / DATE	DNZ 01/24/18	APPROVED BY / DATE	
REVISION HISTORY		REV.	SCALE 1/8
		SIZE	C 1 / 1