

3D
SCALE 1/12

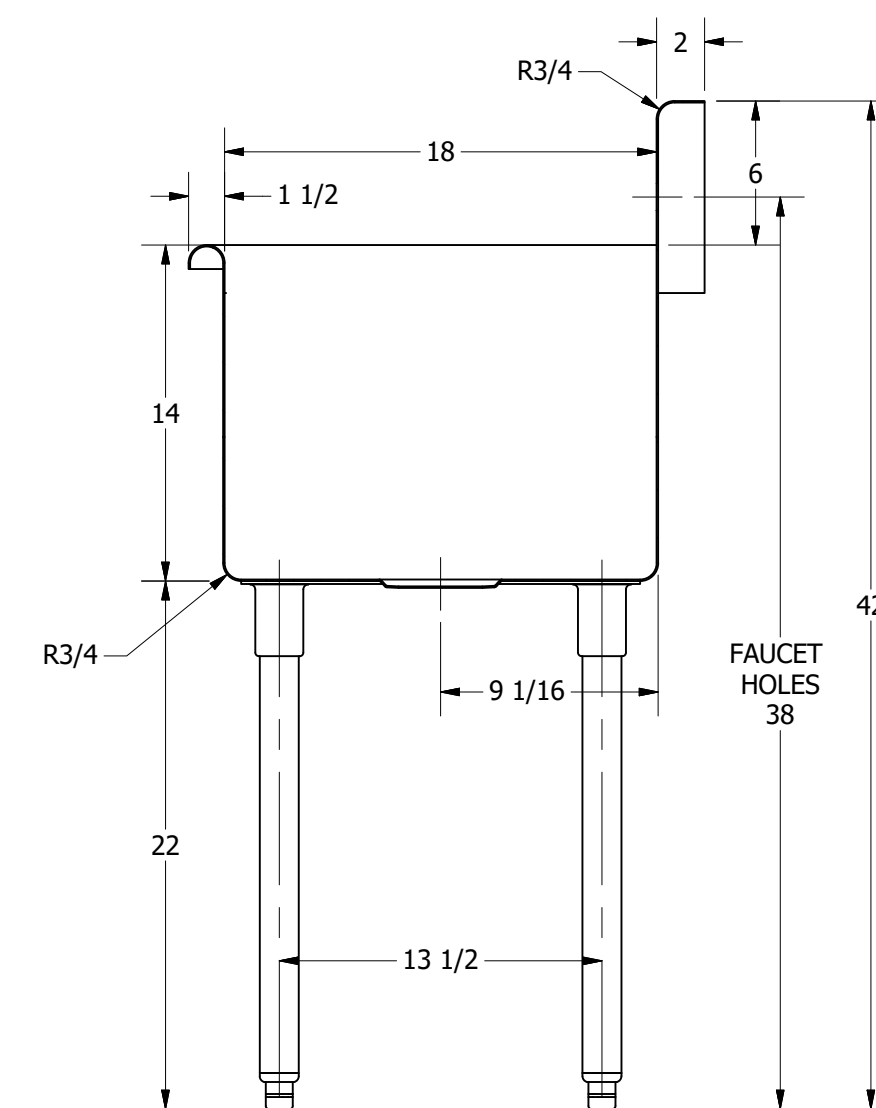
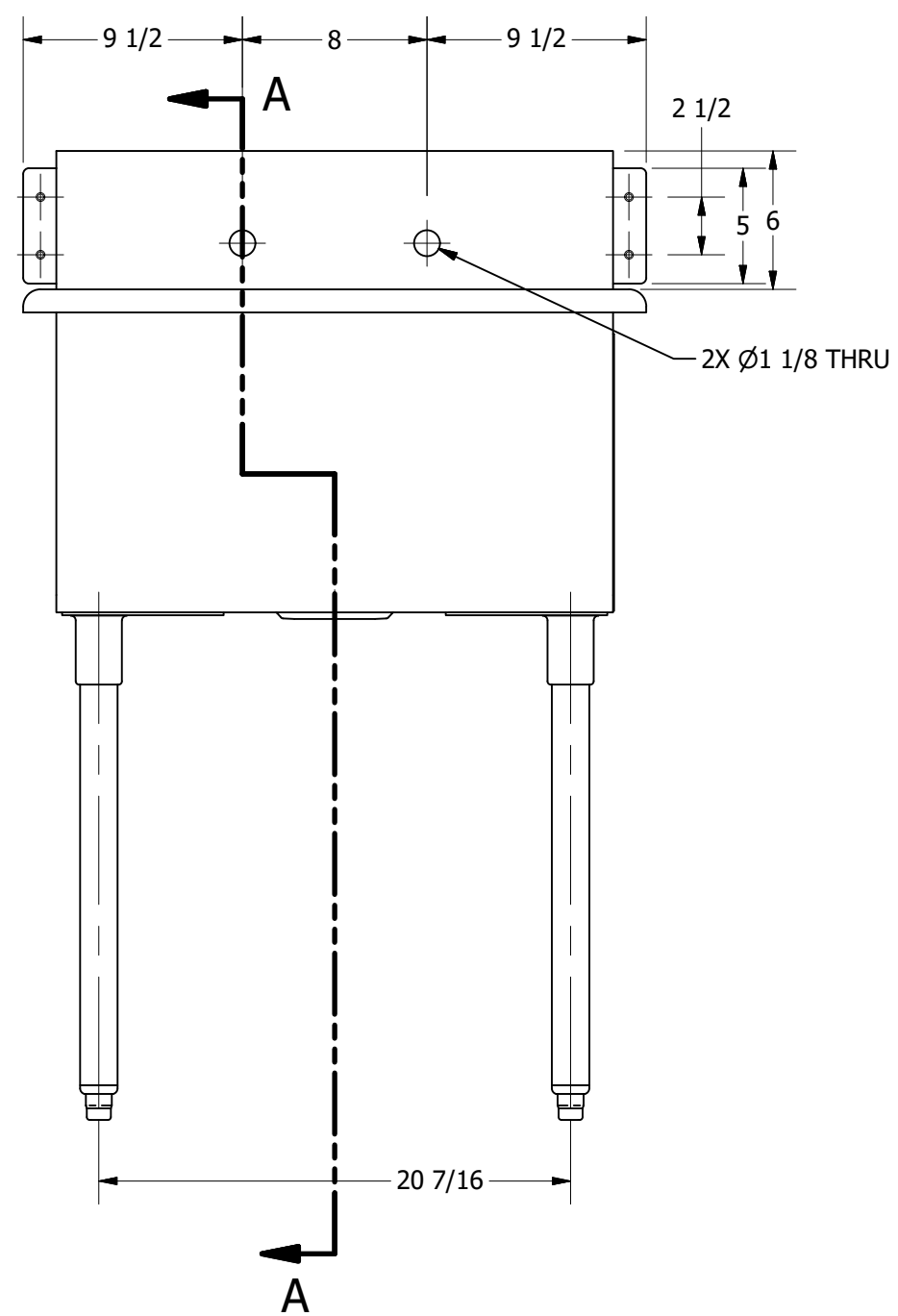

SECTION A-A
SCALE 1/8

REV	DESCRIPTION	DATE	APPROVED

REVISION HISTORY



PART NUMBER	TE 148.00	TITLE	TERRELL SERIES SQUARE SINK
PRODUCT CATEGORY	SQUARE SINK	DESCRIPTION	16GA 1 COMPARTMENT SINK
THE INFORMATION CONTAINED IN THIS DRAWING IS THE SOLE PROPERTY OF GRIFFIN PRODUCTS, INC. ANY REPRODUCTION IN PART OR AS A WHOLE WITHOUT THE WRITTEN PERMISSION FROM GRIFFIN PRODUCTS, INC. IS PROHIBITED.		MATERIAL	16GA (0.06 in) 304 STAINLESS STEEL
DRW. BY / DATE	DNZ 01/24/18	APPROVED BY / DATE	
		REV.	SCALE
			1/8
		SIZE	C
		SHEET	1 / 1

ALL DIMENSIONS ARE IN X INCHES