

3D  
SCALE 1/12

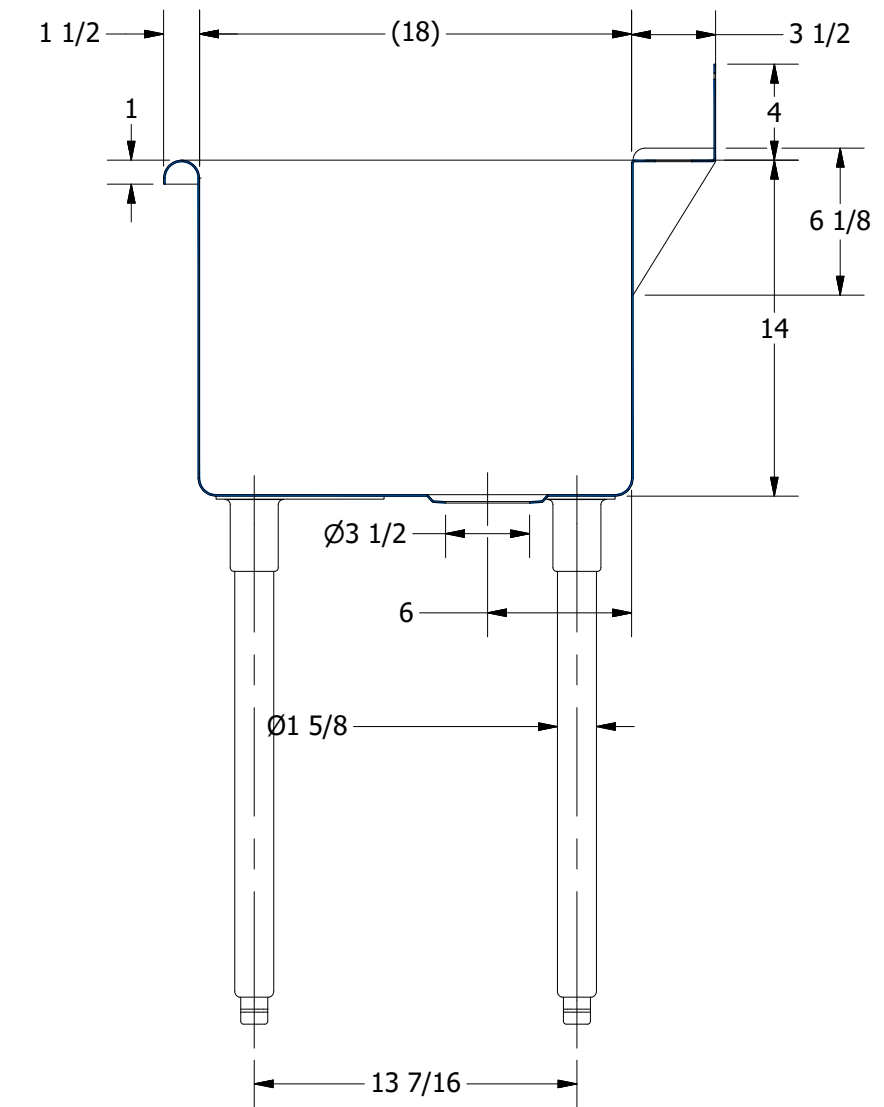

SECTION A-A  
SCALE 1/8

REV	DESCRIPTION	DATE	APPROVED
REVISION HISTORY			

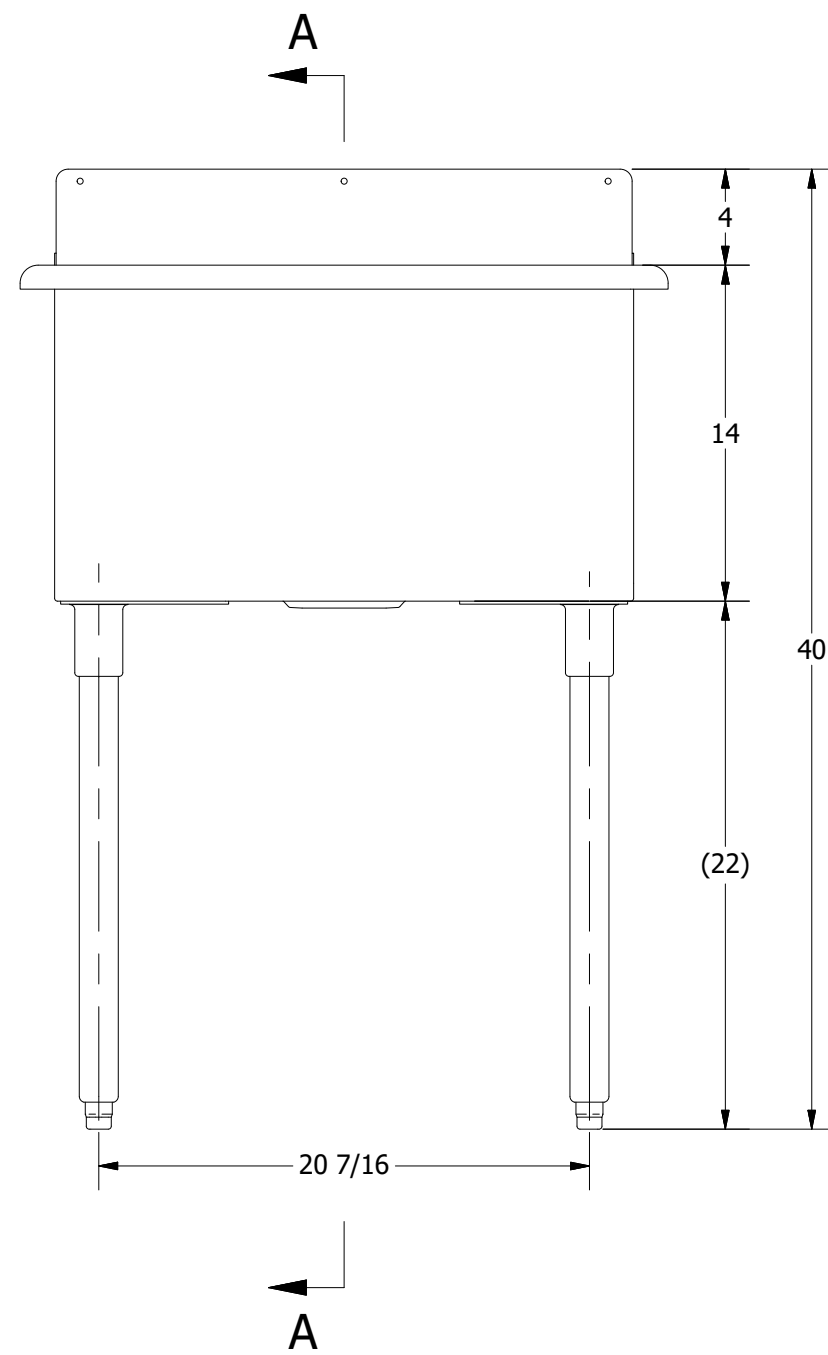

PART NUMBER	<b>LT-148.210</b>	TITLE	MEDINA SERIES UTILITY SINK
PRODUCT CATEGORY	UTILITY SINK	DESCRIPTION	16 GA UTILITY SINK WITH PULL DOWN SPRAYER FAUCET
THE INFORMATION CONTAINED IN THIS DRAWING IS THE SOLE PROPERTY OF GRIFFIN PRODUCTS, INC. ANY REPRODUCTION IN PART OR AS A WHOLE WITHOUT THE WRITTEN PERMISSION FROM GRIFFIN PRODUCTS, INC. IS PROHIBITED.		MATERIAL	16GA (0.06) 304 STAINLESS STEEL
DRW. BY / DATE	DNZ 11/03/18	APPROVED BY / DATE	
		REV.	SCALE 1/8
		SIZE	C 1 / 1