

3D
SCALE 1/12

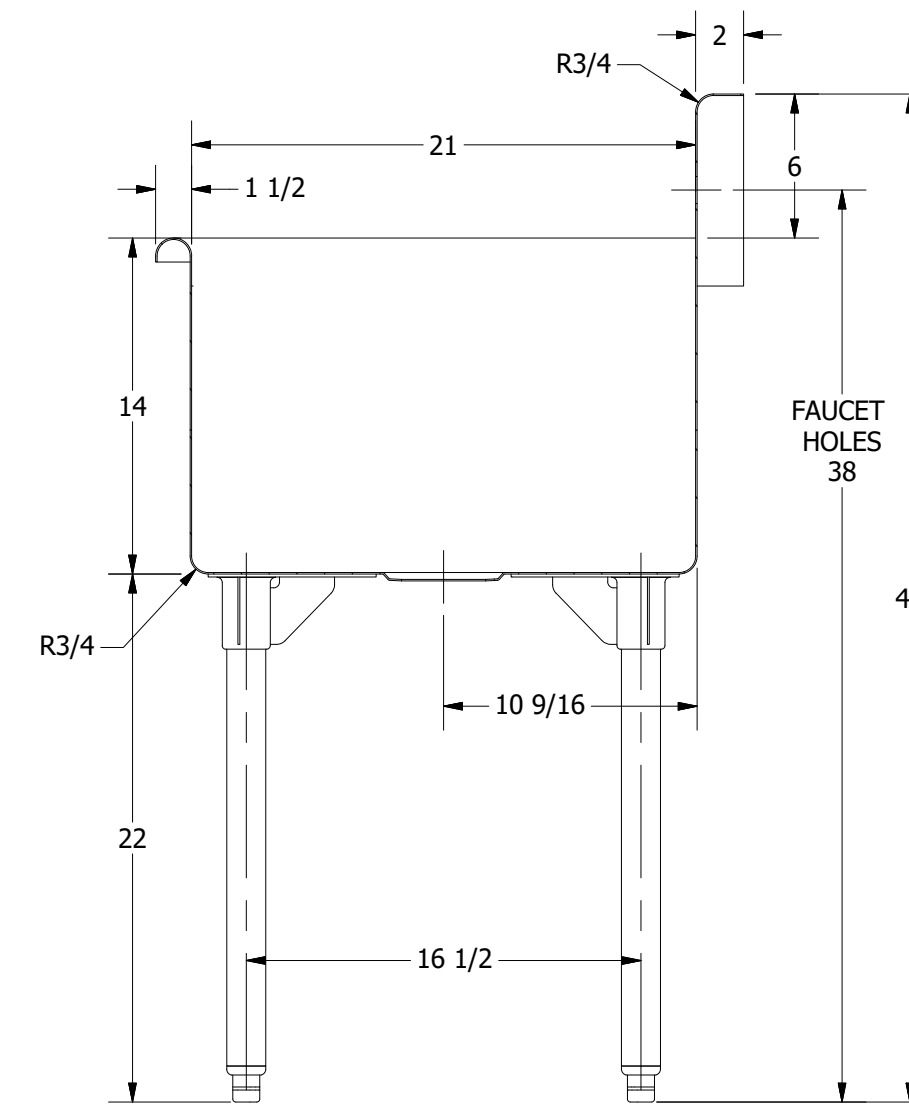

SECTION A-A
SCALE 1/8

REV	DESCRIPTION	DATE	APPROVED
REVISION HISTORY			

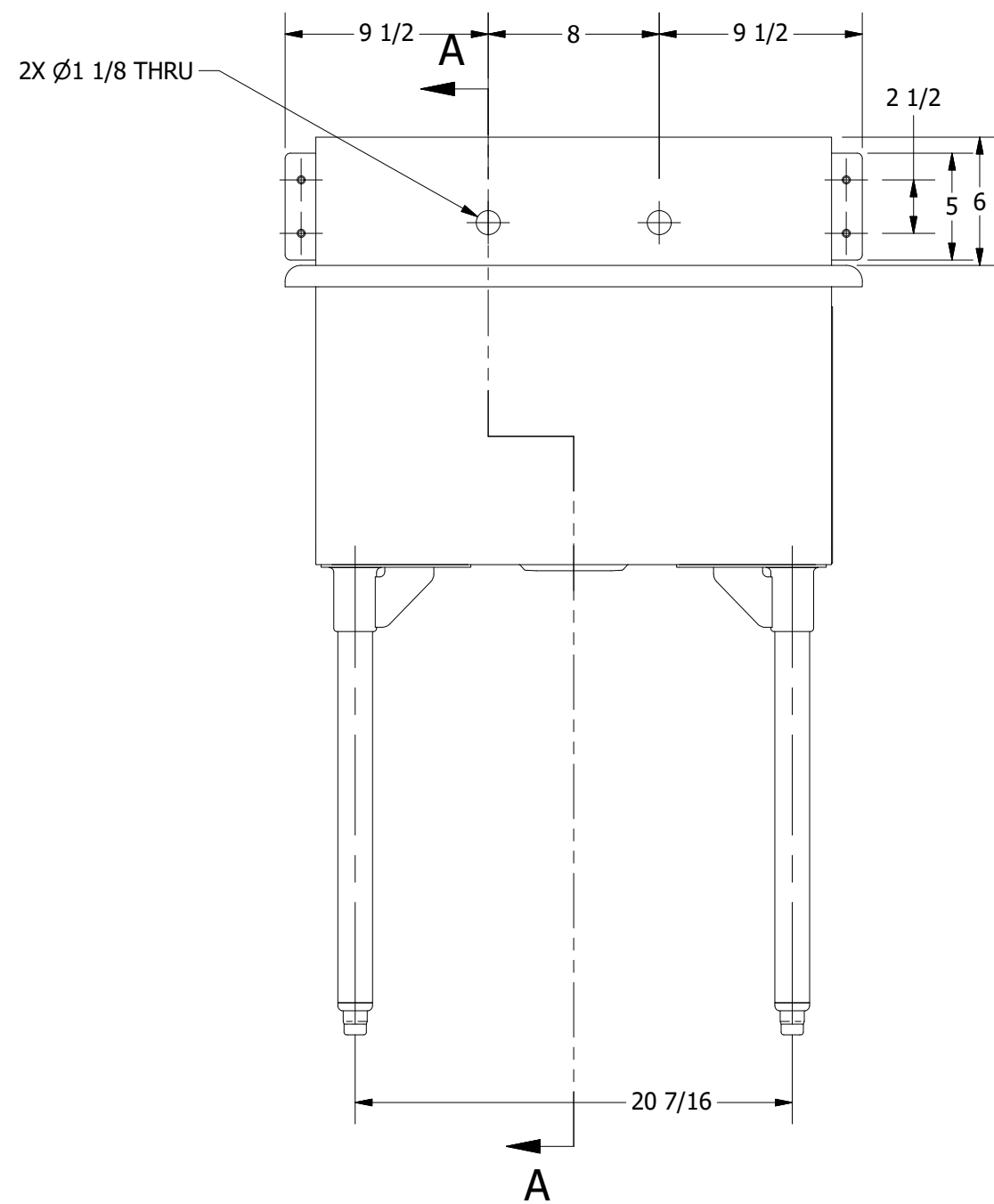

PART NUMBER	WC_141.00	TITLE	WICHITA SERIES SQUARE SINK
PRODUCT CATEGORY	SQUARE SINK	DESCRIPTION	14 GA 1 COMPARTMENT SINK
THE INFORMATION CONTAINED IN THIS DRAWING IS THE SOLE PROPERTY OF GRIFFIN PRODUCTS, INC. ANY REPRODUCTION IN PART OR AS A WHOLE WITHOUT THE WRITTEN PERMISSION FROM GRIFFIN PRODUCTS, INC. IS PROHIBITED.		MATERIAL	14GA (0.075 in) 304 STAINLESS STEEL
DRW. BY / DATE	DNZ 01/24/18	APPROVED BY / DATE	
		ALL DIMENSIONS ARE IN X INCHES	
REV.	SCALE	SIZE	SHEET
	1/8	C	1 / 1