

SECTION A-A
SCALE 1:12

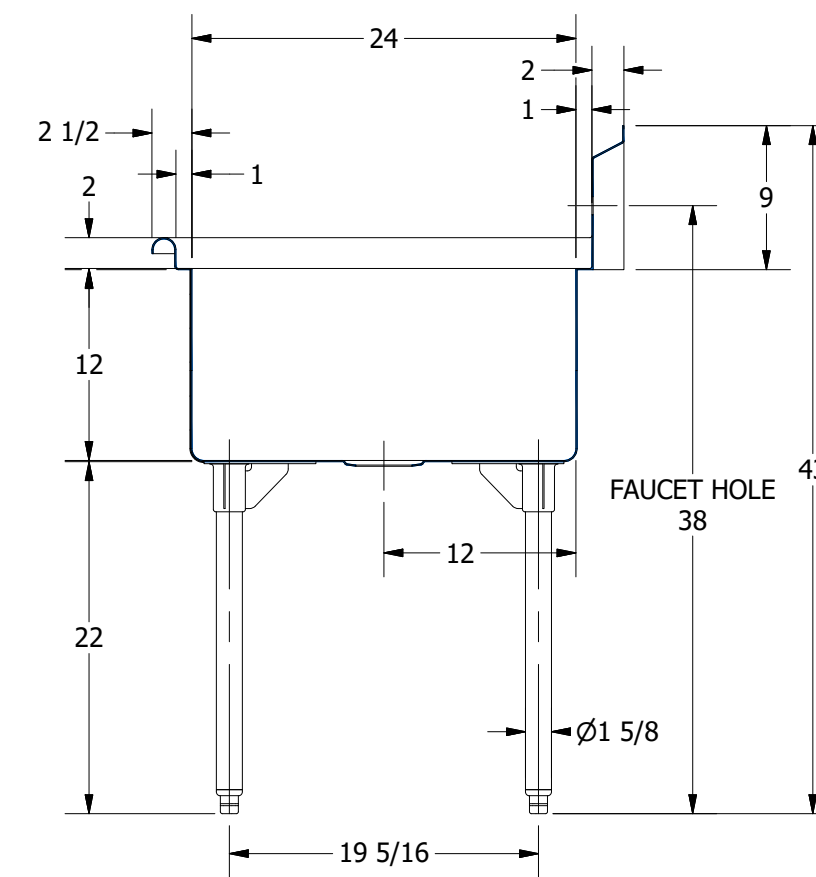

SECTION B-B
SCALE 1:12

REV	DESCRIPTION	DATE	APPROVED
REVISION HISTORY			



PART NUMBER	134.04	TITLE	TRINITY SERIES SCULLERY SINK
PRODUCT CATEGORY	SCULLERY SINK	DESCRIPTION	14GA SINGLE COMPARTMENT SINK WITH RIGHT DRAINBOARD
THE INFORMATION CONTAINED IN THIS DRAWING IS THE SOLE PROPERTY OF GRIFFIN PRODUCTS, INC. ANY REPRODUCTION IN PART OR AS A WHOLE WITHOUT THE WRITTEN PERMISSION FROM GRIFFIN PRODUCTS, INC. IS PROHIBITED.		MATERIAL	14GA (0.075 in) 304 STAINLESS STEEL
DRW. BY / DATE	DNZ 01/24/18	APPROVED BY / DATE	
		ALL DIMENSIONS ARE IN X INCHES	
REV.	SCALE	SIZE	SHEET
	1:12	C	1 / 1