

SIENNA DROP - IN WASH BASIN

Cat. No.
4-709



Drain not included

W: 15½"
D: 12⅞"
H: 6"
Flange: 3" x 1⅜" deep

Features:

- ▶ Made of Vitreous China
- ▶ Fluted basin
- ▶ Traditional style
- ▶ Self rimming

Colors:

WH White
BQ Bisque

Compliance Certification

Meets or exceeds the following specifications: ASME 12.19.2.2013 for vitreous china fixtures.

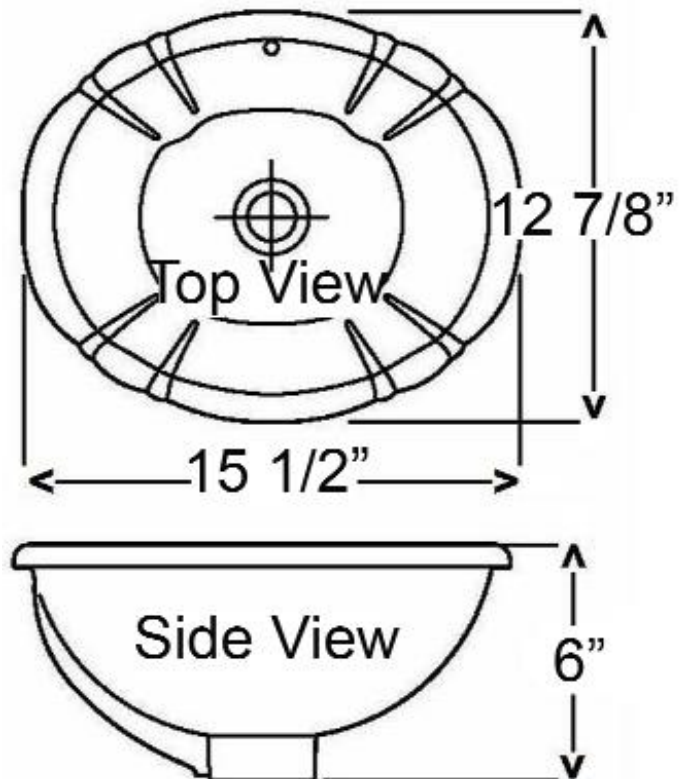

Interior Dimensions:

Basin Interior: 12¾" x 10"
Basin Depth: 4⅝"

Dimensions of fixture are nominal and may vary within the range of tolerances established by ASME Standard A112.19.2.2013. Dimensions and specifications subject to change without notice.