

Always check the website for the most updated specifications: [www.americh.com](http://www.americh.com)

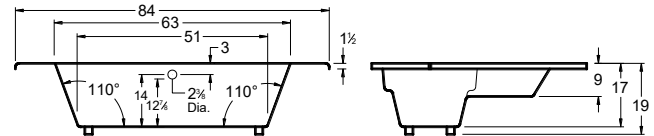

All bathtub dimensions are  $\pm 1/2"$ .

## Builder Series

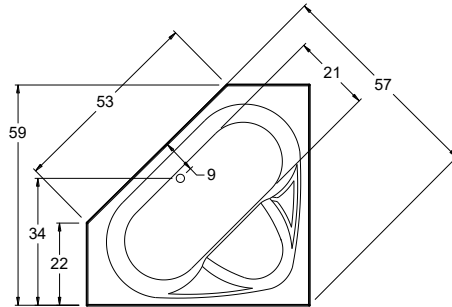
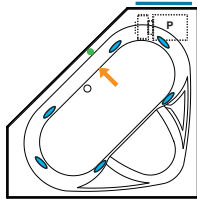

## Luxury Series

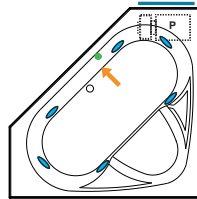

## Platinum Series

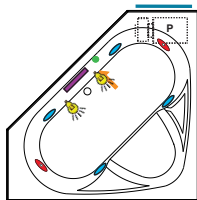

## Combination

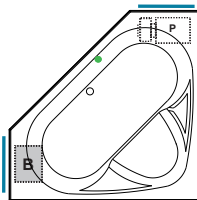

## Airbath System II

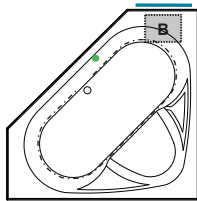

## Airbath System

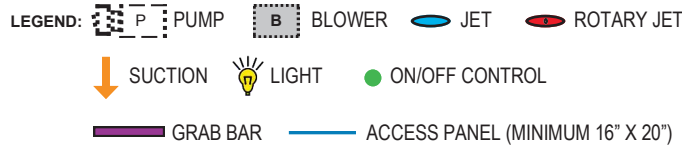
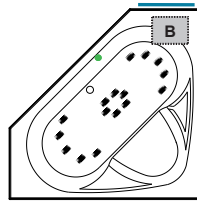

### INSTALLATION TIPS

- Install according to Owner's Manual and local codes. Always consult your local plumber for recommendations.
- Certain options or altering the pump/blower location may cause the pump/blower to extend beyond the tub decking.
- Airbath III units may be 1 1/2" – 2 1/2" taller than stated.
- Hot water supply should be 65-75% of the tub capacity or greater.
- Cut Dimensions: Americh recommends waiting until the actual unit is received.
- All specifications are subject to change without notice.
- The combination of multiple systems and options may require components to stick out and/or be remotely installed in the field.

### DIMENSIONS

59" x 59" x 19" deep (1499 x 1499 x 483 mm)  
Whirlpool Operating Gallons = 50 (Liters = 189)  
Gallon to Overflow = 65 (Liters = 246)

**MATERIAL:** Acrylic (All Americh Standard Colors)

**TUB FLOOR:** Textured

**UNDERMOUNT:** No

### ELECTRICAL REQUIREMENTS

Americh recommends one 20 amp ground fault circuit interrupter (GFCI) for each power supply provided with the bathtub.

### STANDARD EQUIPMENT:

- Adjustable Feet

### OPTIONAL ACCESSORIES

- Apron (Bermuda Apron Only)  
Factory installed aprons may increase the overall height of the tub when ordered with certain accessories (ie. Linear Drain).
- Chromatherapy\*
- Grab Bars: 9" \* - 14" - 16"
- High Density Insulation\*
- iBath Sound System
- Inline Heater (whirlpool only)
- Jets: Additional or Rotary\*
- Lo Profile Tub Edge
- Ozone System (whirlpool and/or Airbath only)
- Pillows: 12" \*
- Remote Control Upgrade (select series only)
- Serenity Soak (tub only)
- Syllent Pump with Heated Air\*
- Thermal Comfort System  
(TCS must be at opposite end if used with VSM)
- Tile Flange Kit
- Trim Kit Upgrade\*
- Vibro Sonic Massage  
(VSM must be at opposite end if used with TCS)
- Waste & Overflows Upgrades
  - Cable Drive Waste & Overflow\*
  - PVC Waste & Overflow\*

(\* ) Standard on Platinum Series

(+ ) Standard on Luxury Series

### CODES AND COMPLIANCE

Americh products meet or exceed the following standards:

- Underwriters Laboratories (UL)
- Underwriters Laboratories - Canada (cUL)
- Canadian Standards Association - (CSA)
- ANSI Z124.1 • ANSI A112-19.7
- ANSI A112.19.8

Contact Americh for additional approvals.