

F3LR SERIES, Three Compartment with Two Drainboards

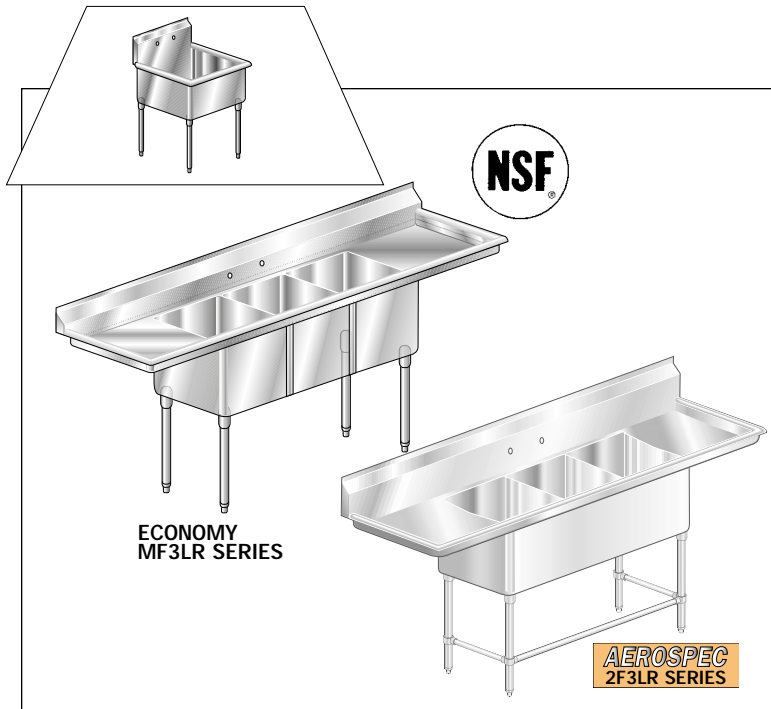

Item# _____ Project _____

Quantity	ECONOMY MF3 Model #	DELUX 3F3 Model #	AEROSPEC 2F3 Model #
21" WIDE			
—	MF3-2116-18LR	3F3-2116-18LR	2F3-2116-18LR
—	MF3-2116-24LR	3F3-2116-24LR	2F3-2116-24LR
—	MF3-2116-30LR	3F3-2116-30LR	2F3-2116-30LR
—	MF3-2116-36LR	3F3-2116-36LR	2F3-2116-36LR

20" WIDE			
—	MF3-2020-20LR	3F3-2020-20LR	2F3-2020-20LR
—	MF3-2020-24LR	3F3-2020-24LR	2F3-2020-24LR
—	MF3-2020-30LR	3F3-2020-30LR	2F3-2020-30LR
—	MF3-2020-36LR	3F3-2020-36LR	2F3-2020-36LR

24" WIDE			
—	MF3-2418-18LR	3F3-2418-18LR	2F3-2418-18LR
—	MF3-2418-24LR	3F3-2418-24LR	2F3-2418-24LR
—	MF3-2418-30LR	3F3-2418-30LR	2F3-2418-30LR
—	MF3-2418-36LR	3F3-2418-36LR	2F3-2418-36LR

24" WIDE			
—	MF3-2424-18LR	3F3-2424-18LR	2F3-2424-18LR
—	MF3-2424-24LR	3F3-2424-24LR	2F3-2424-24LR
—	MF3-2424-30LR	3F3-2424-30LR	2F3-2424-30LR
—	MF3-2424-36LR	3F3-2424-36LR	2F3-2424-36LR

30" WIDE			
—	MF3-3020-20LR	3F3-3020-20LR	2F3-3020-20LR
—	MF3-3020-24LR	3F3-3020-24LR	2F3-3020-24LR
—	MF3-3020-30LR	3F3-3020-30LR	2F3-3020-30LR
—	MF3-3020-36LR	3F3-3020-36LR	2F3-3020-36LR

MATERIAL

BODY

- MF -16 gauge 304 stainless steel bowl, 430 body.
- 3F -16 gauge 304 stainless steel.
- 2F -14 gauge 304 stainless steel. (AEROSPEC)

LEGS

- 1 3/4" O.D. 16 gauge 304 series stainless steel tubing, complete with 1" adjustable impact resistant white metal feet.

DESIGN FEATURES

- All sinks are fully cartoned.
- Easily assembled.
- Drainboards pitched 3/8" for positive drainage.

EXCLUSIVE AERO SAFETY EDGE

- Sink hemmed on the roll and backsplash to eliminate cuts from rough edges.

CONSTRUCTION

- **Exclusive 14" bowl depth on all models (consultant's spec).**
- **Custom style fabricated bowl for true gauge integrity.**
- All sinks have a 3/8" radius at all intersecting planes (consultant's spec).
- 18 gauge stainless steel strip to cover seams between bowls.
- Stainless steel gusset is machine welded 360 deg. to a stainless steel triangular plate.
- Gusset plate is fully welded directly underneath the sink for support.
- Polished to a #4 blended finish.
- All sinks with drainboards 30" or longer equipped with 2 stainless steel 1 3/4" O.D. legs with stainless steel gussets and white metal feet.

PLUMBING

- Water supply is 1/2" hot and cold.
- Faucet holes are 8" o.c. (Faucets not included. See accessories).

AEROSPEC

Includes all of the above and the following:

- Full 10" backsplash instead of standard 7".
- 18 gauge stainless steel enclosure surrounding all sink bowls.
- Stainless steel feet in lieu of white metal.
- Legs have stainless steel crossbracing with aluminum castings at all intersections.

CUSTOM SIZES AVAILABLE

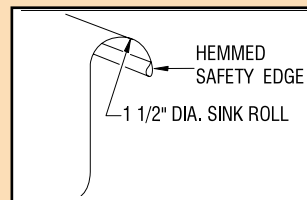

Exclusive
Aero Safety Edge

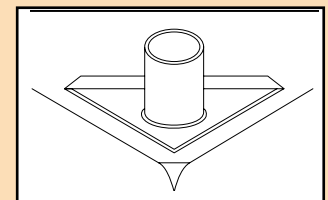

Fully Welded
Gusset Assembly

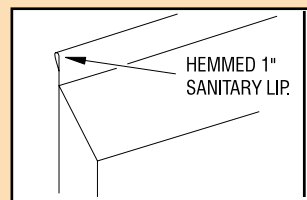

1" Sanitary Lip

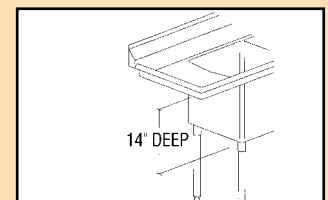

14" Custom-Style
Bowl

CONSULTANT'S SPECS AT PRODUCTION PRICES

email - sales@aeromfg.com

AERO MANUFACTURING COMPANY • 310 ALLWOOD ROAD, CLIFTON, NEW JERSEY 07012 • VOICE 973.473.5300 FAX 973.473.3794



DIMENSIONAL SPECIFICATIONS

F3LR SERIES, NSF Sinks, Three Compartment, Two Drainboards

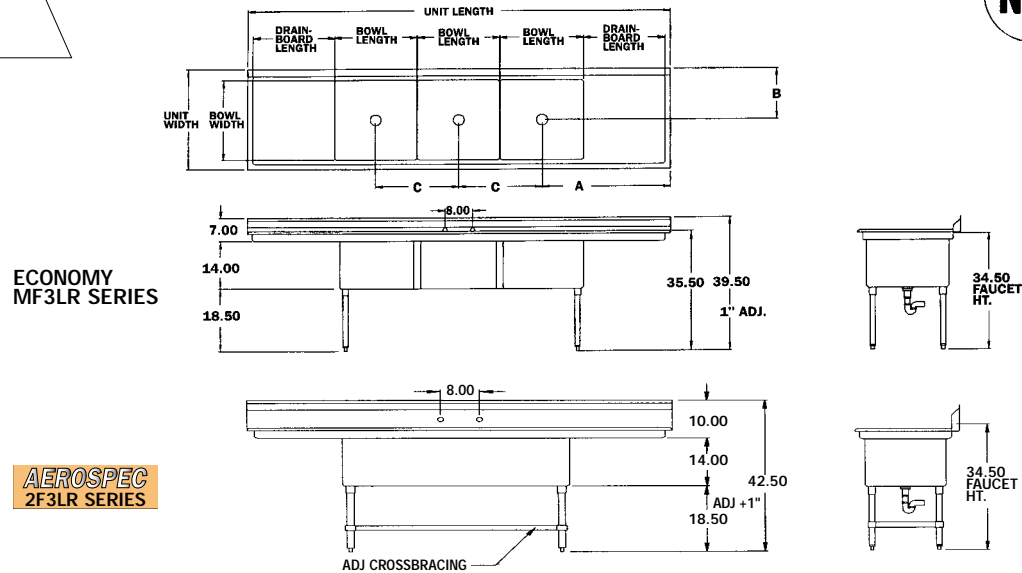

■ Supplied with stainless steel drain basket and strainer.

BOWL Width	BOWL Length	UNIT Width	UNIT Length	DRAIN BOARD Length	A Drain	B Drain	C Drain	ECONOMY MF3 Model #	DELUX 3F3 Model #	AEROSPEC 2F3 Model #	Ship Weight	Cubic Feet	Sets, Faucet Holes
21" WIDE													
21	16	27	87	18	27.5	13.75	16	MF3-2116-18LR	3F3-2116-18LR	2F3-2116-18LR	150	29	ONE
21	16	27	99	24	33.5	13.75	16	MF3-2116-24LR	3F3-2116-24LR	2F3-2116-24LR	160	32	ONE
21	16	27	101	30	39.5	13.75	16	MF3-2116-30LR	3F3-2116-30LR	2F3-2116-30LR	165	33	ONE
21	16	27	123	36	45.5	13.75	16	MF3-2116-36LR	3F3-2116-36LR	2F3-2116-36LR	170	40	ONE
20" WIDE													
20	20	26	99	20	29.5	13.25	20	MF3-2020-20LR	3F3-2020-20LR	2F3-2020-20LR	200	32	TWO
20	20	26	111	24	35.5	13.25	20	MF3-2020-24LR	3F3-2020-24LR	2F3-2020-24LR	205	35	TWO
20	20	26	123	30	41.5	13.25	20	MF3-2020-30LR	3F3-2020-30LR	2F3-2020-30LR	210	39	TWO
20	20	26	135	36	47.5	13.25	20	MF3-2020-36LR	3F3-2020-36LR	2F3-2020-36LR	215	43	TWO
24" WIDE													
24	18	30	93	18	28.5	13.75	18	MF3-2418-18LR	3F3-2418-18LR	2F3-2418-18LR	165	31	ONE
24	18	30	105	24	34.5	13.75	18	MF3-2418-24LR	3F3-2418-24LR	2F3-2418-24LR	170	34	ONE
24	18	30	117	30	40.5	13.75	18	MF3-2418-30LR	3F3-2418-30LR	2F3-2418-30LR	175	38	ONE
24	18	30	129	36	46.5	13.75	18	MF3-2418-36LR	3F3-2418-36LR	2F3-2418-36LR	180	42	ONE
24" WIDE													
24	24	30	111	18	31.5	15.25	24	MF3-2424-18LR	3F3-2424-18LR	2F3-2424-18LR	230	40	TWO
24	24	30	123	24	37.5	15.25	24	MF3-2424-24LR	3F3-2424-24LR	2F3-2424-24LR	235	45	TWO
24	24	30	135	30	43.5	15.25	24	MF3-2424-30LR	3F3-2424-30LR	2F3-2424-30LR	240	49	TWO
24	24	30	147	36	49.5	15.25	24	MF3-2424-36LR	3F3-2424-36LR	2F3-2424-36LR	245	54	TWO
30" WIDE													
30	20	36	99	20	29.5	18.25	20	MF3-3020-20LR	3F3-3020-20LR	2F3-3020-20LR	240	43	TWO
30	20	36	111	24	35.5	18.25	20	MF3-3020-24LR	3F3-3020-24LR	2F3-3020-24LR	250	49	TWO
30	20	36	123	30	41.5	18.25	20	MF3-3020-30LR	3F3-3020-30LR	2F3-3020-30LR	260	54	TWO
30	20	36	135	36	47.5	18.25	20	MF3-3020-36LR	3F3-3020-36LR	2F3-3020-36LR	270	59	TWO

All dimensions are typical (tol. ±1/2"). • For Accessories and Options see pages FS-7A, FS-7B.

email - sales@aeromfg.com

AERO MANUFACTURING COMPANY • 310 ALLWOOD ROAD, CLIFTON, NEW JERSEY 07012 • VOICE 973.473.5300 FAX 973.473.3794